

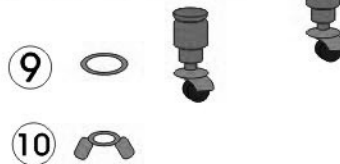

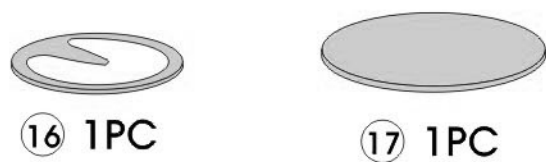

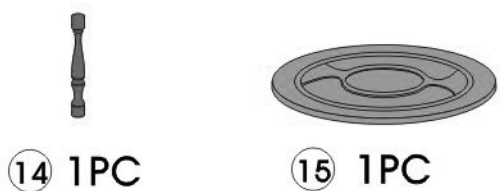

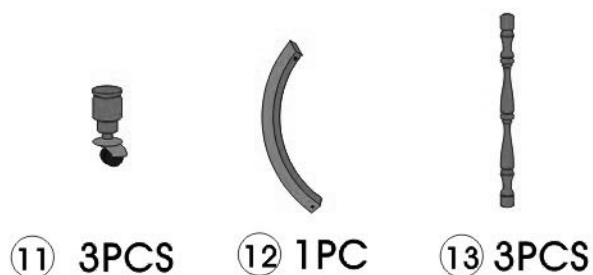

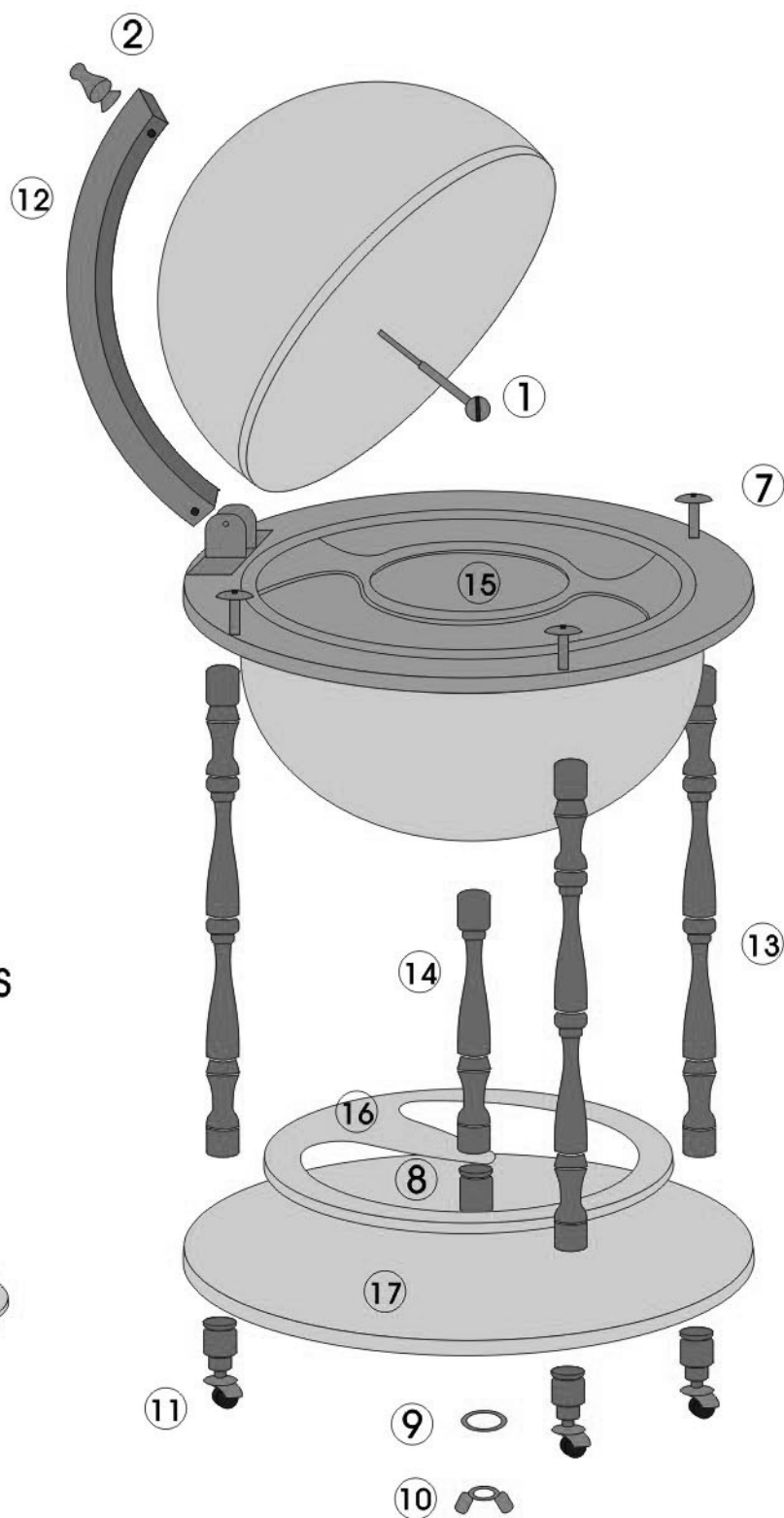
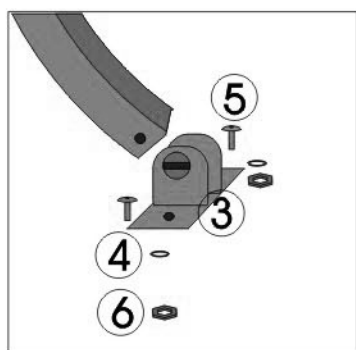

GLOBE BAR MANUAL



- | | | | | | | | | | | | | | | |
|---|---|-----|---|---|------|---|---|------|---|---|------|---|---|-----|
| ① |  | 1PC | ③ |  | 1PC | ⑤ |  | 2PCS | ⑦ |  | 3PCS | ⑨ |  | 1PC |
| ② |  | 1PC | ④ |  | 2PCS | ⑥ |  | 2PCS | ⑧ |  | 1PC | ⑩ |  | 1PC |